

# HSF

**NOTES:**

Rated Current:3.0AMP.(20°C,2\*2P-2\*15P)  
 2.0AMP.(20°C,2\*16P-2\*40P)  $\Delta 3$   
 Contact Resistance:20m $\Omega$  Max.  
 Withstand Voltage:500V AC/DC  
 Insulation Resistance:1000M $\Omega$  Min.  
 Operation Temperature: -40°C to +125°C(Gold Plating)  
 -40°C to +105°C(Tin Plating)  $\Delta 3$   
 Contact Material:Copper Alloy  
 Contact Plating: Au or Sn Over 30u" Min Ni  $\Delta 3$   
 Insulator Material:PA9T+G.F UL94V-0 BK  $\Delta 3$

## Ordering Information

1220- 1 2 XX XX M XXX C R XX  $\Delta 1$

Plastic Layer  
 Plastic Row  
 No. of Pins  
 Per Row:02-40  
 Contact Plating  
 G0=Gold Flash  
 G3=10u"Au, BG3=8u"PdNi+2u"Au  
 G4=15u"Au, BG4=13u"PdNi+2u"Au  
 G5=30u"Au, BG5=28u"PdNi+2u"Au  
 S0=Gold Flash/Tin  
 S3=10u"Au/Sn, P3=8u"PdNi+2u"Au/Sn  
 S4=15u"Au/Sn, P4=13u"PdNi+2u"Au/Sn  
 S5=30u"Au/Sn, P5=28u"PdNi+2u"Au/Sn  
 SN=Bright Tin  
 SM=Matte Tin  
 Series No.  
 01-99  
 Packing  
 T=Tube  
 P=Tube+CAP  
 R=Tape & Reel+CAP  
 Insulator Material  
 C=PA9T  
 Pin Length  
 L(See Table)  
 Type:  
 M:SMT

Item	Pin Length	W	E	D	B	Mating
Standard	6.8	6.5	2.6	0.1	2.5	2220T/2221/2228
	7.3				3.0	2227T/2228T/2245
	7.8				3.5	2235/2240N/2243C
	8.3				4.0	2240/2243/2245T/2263/2272
Alternate						

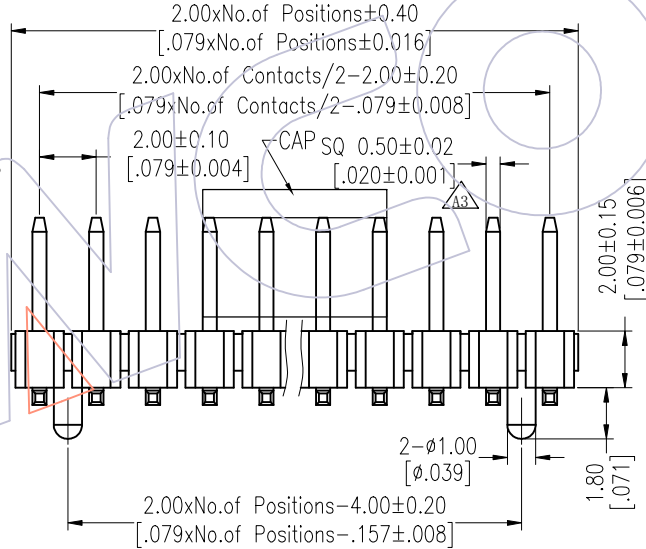
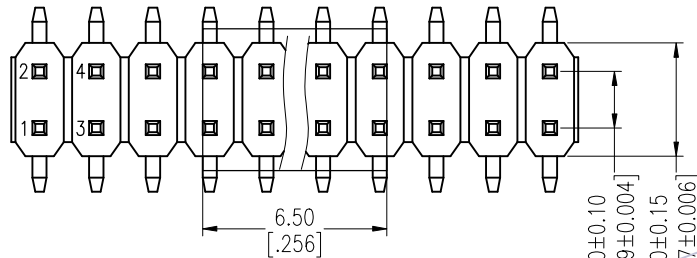

PIN(PerRow)	2-15P	16-25P	26-40P
M	0.10	0.15	0.18

Recommended P.C.B Layout (Top Side)  
 (PCB BOARD TOLERANCE±0.05)  
 (PCB Thickness:T=1.60m)

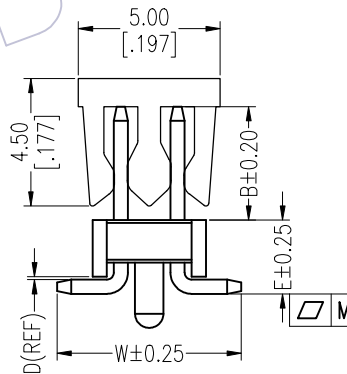
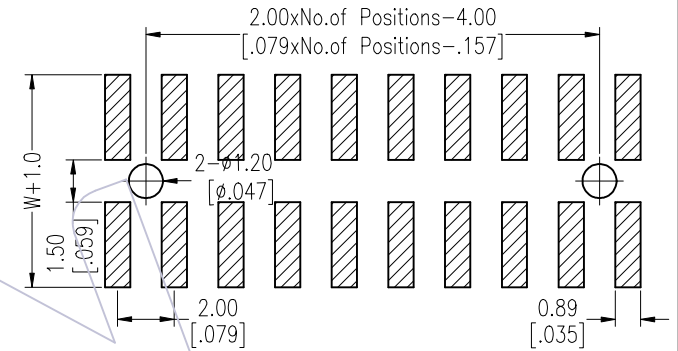

TYPE 2 WITH POST

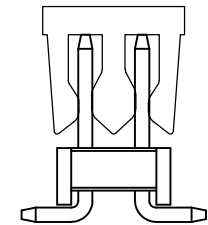

TYPE 1 W/O POST

REV	DATE	MODIFICATION DESCRIPTION	CHANGE	OPERATION	DATE	SCALE	Fit	PART NO.
A3	2025/04/10	Standardization Drawing	CP	OPERATION	DRAW	SCALE	Fit	PART NO. 1220-12XXXXMXXXCRXX $\Delta 1$
A2	2023/02/02	Add Flatness	DuYing	x.X ±0.40	CP	UNIT	mm	TITLE: PH2.00 DUAL ROW SMT H=2.0
A1	2018/01/18	Modify P/N	Liu	x.XX ±0.25	CHECK	SIZE	A4	
A0	2012/04/26	NEW	William Chen	x.XXX ±0.15	TANG	SHEET	1/3	Customer NO.
				Angle ± 3'	APPROVE	PROJ.		
				DIM TOL	Steven Zhao			

**WCON**  
 Http: www.wcon.com

WCON-Dongguan  
 Tel: +86 769 85358920  
 Fax: +86 769 85358915  
 E-mail: sales@wcon.com

WCON-Kunshan  
 Tel: +86 512 57468408  
 Fax: +86 512 57468468  
 E-mail: salesks@wcon.com

**HSF**

**Packing:**

**Tube:**

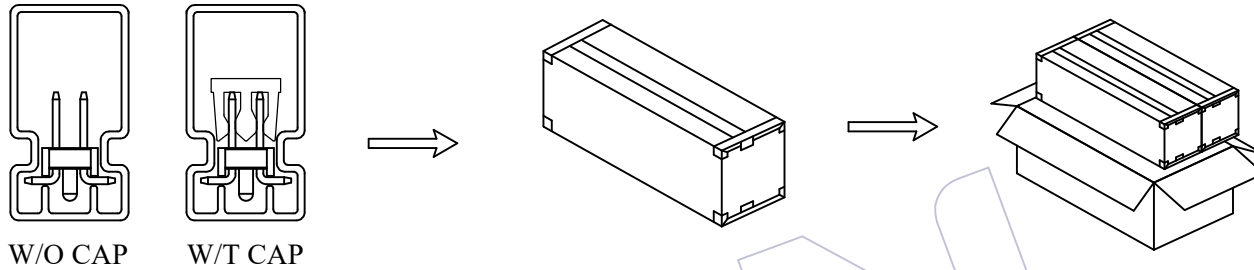

Tube

Inner Box

Box

**Reel:**

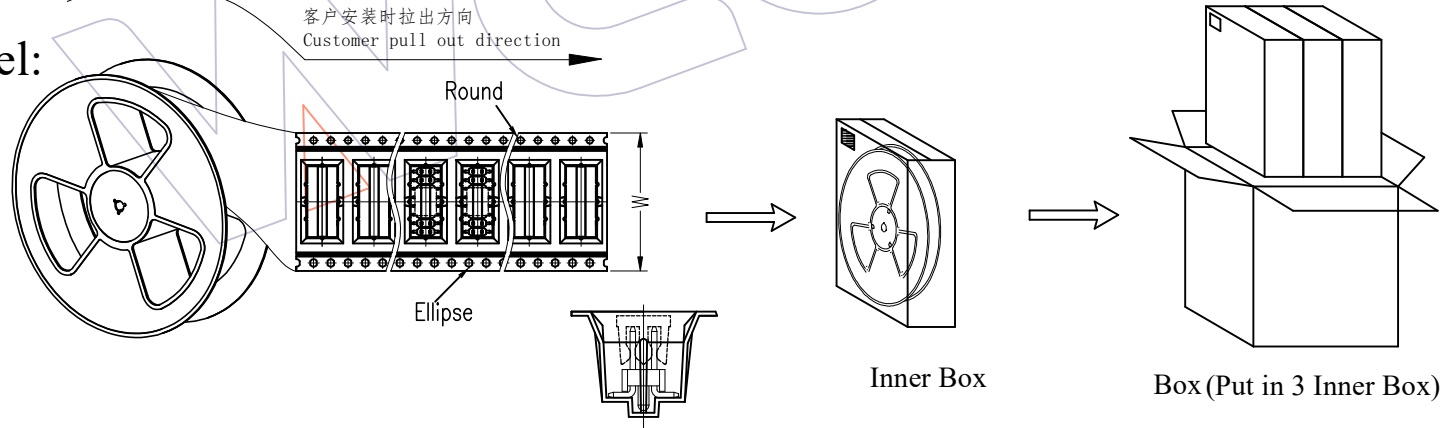

Inner Box

Box (Put in 3 Inner Box)

A3	2025/04/10	Standardization Drawing	CP	OPERATION	DRAW	DATE	SCALE	Fit	PART NO.
A2	2023/02/02	Add Flatness	DuYing	x.X ±0.40	CP	2025/04/10	UNIT	mm	1220-12XXXXMXXCRXX $\Delta$
A1	2018/01/18	Modify P/N	Liu	x.XX ±0.25	CHECK	DATE	SIZE	A4	TITLE:
A0	2012/04/26	NEW	William Chen	x.XXX ±0.15	TANG	2025/04/10	SHEET	2/3	PH2.00 DUAL ROW SMT H=2.0
REV	DATE	MODIFICATION DESCRIPTION	CHANGE	Angle ± 3'	APPROVE	DATE	PROJ.		Customer NO.
				DIM TOL	Steven Zhao	2025/04/10			

**WCON**

Http: [www.wcon.com](http://www.wcon.com)

WCON-Dongguan Tel: +86 769 85358920 Fax: +86 769 85358915 E-mail: <a href="mailto:sales@wcon.com">sales@wcon.com</a>	WCON-Kunshan Tel: +86 512 57468408 Fax: +86 512 57468468 E-mail: <a href="mailto:salesks@wcon.com">salesks@wcon.com</a>
---	--

**HSF**

**Packaging Quantity Refers To The Following Table**

PINS /Row	Q'ty/Tube	Q'ty/Inner Box	Q'ty/Box
4	72	8,640	17,280
5	58	6,960	13,920
6	48	5,760	11,520
7	41	4,920	9,840
8	36	4,320	8,640
9	32	3,840	7,680
10	29	3,480	6,960
11	25	3,000	6,000
12	24	2,880	5,760
13	22	2,640	5,280
14	20	2,400	4,800
15	19	2,280	4,560
16	18	2,160	4,320
17	17	2,040	4,080
18	15	1,800	3,600
19	15	1,800	3,600
20	14	1,680	3,360
21	13	1,560	3,120
22	13	1,560	3,120

PINS /Row	Q'ty/Tube	Q'ty/Inner Box	Q'ty/Box
23	12	1,440	2,880
24	11	1,320	2,640
25	11	1,320	2,640
26	11	1,320	2,640
27	10	1,200	2,400
28	10	1,200	2,400
29	9	1,080	2,160
30	9	1,080	2,160
31	9	1,080	2,160
32	9	1,080	2,160
33	8	960	1,920
34	8	960	1,920
35	8	960	1,920
36	8	960	1,920
37	7	840	1,680
38	7	840	1,680
39	7	840	1,680
40	7	840	1,680

**B=2.5/3.0/3.5**

PINS /Row	W	Q'ty/Reel	Q'ty/Inner Box	Q'ty/Box
2	16	550	2,200	6,600
3	24	550	1,650	4,950
4	24	550	1,650	4,950
5	24	550	1,650	4,950
6	24	550	1,650	4,950
7	32	550	1,100	3,300
8	32	550	1,100	3,300
9	44	550	1,100	3,300
10	44	550	1,100	3,300
11	44	550	1,100	3,300
12	44	550	1,100	3,300
13	44	550	1,100	3,300
14	44	550	1,100	3,300
15	56	550	550	1,650
16	56	550	550	1,650
17	56	550	550	1,650
18	56	550	550	1,650

**B=2.5/3.0/3.5**

PINS /Row	W	Q'ty/Reel	Q'ty/Inner Box	Q'ty/Box
19	56	550	550	1,650
20	56	550	550	1,650
21	72	550	550	1,650
22	72	550	550	1,650
23	72	550	550	1,650
24	72	550	550	1,650
25	72	550	550	1,650
26	72	550	550	1,650
27	72	550	550	1,650
28	72	550	550	1,650
29	88	550	550	1,650
30	88	550	550	1,650
31	88	550	550	1,650
32	88	550	550	1,650
33	88	550	550	1,650
34	88	550	550	1,650
35	88	550	550	1,650

**B=4.0**

PINS /Row	W	Q'ty/Reel	Q'ty/Inner Box	Q'ty/Box
2	16	460	1,840	5,520
3	24	460	1,380	4,140
4	24	460	1,380	4,140
5	24	460	1,380	4,140
6	24	460	1,380	4,140
7	32	460	920	2,760
8	32	460	920	2,760
9	44	460	920	2,760
10	44	460	920	2,760
11	44	460	920	2,760
12	44	460	920	2,760
13	44	460	920	2,760
14	44	460	920	2,760
15	56	460	460	1,380
16	56	460	460	1,380
17	56	460	460	1,380
18	56	460	460	1,380

**B=4.0**

PINS /Row	W	Q'ty/Reel	Q'ty/Inner Box	Q'ty/Box
19	56	460	460	1,380
20	56	460	460	1,380
21	72	460	460	1,380
22	72	460	460	1,380
23	72	460	460	1,380
24	72	460	460	1,380
25	72	460	460	1,380
26	72	460	460	1,380
27	72	460	460	1,380
28	72	460	460	1,380
29	88	460	460	1,380
30	88	460	460	1,380
31	88	460	460	1,380
32	88	460	460	1,380
33	88	460	460	1,380
34	88	460	460	1,380
35	88	460	460	1,380

A3	2025/04/10	Standardization Drawing	CP	OPERATION	DRAW	DATE	SCALE	Fit	PART NO.
A2	2023/02/02	Add Flatness	DuYing	x.X ±0.40	CP	2025/04/10	UNIT	mm	1220-12XXXXMXXCRXX $\Delta$
A1	2018/01/18	Modify P/N	Liu	x.XX ±0.25	CHECK	DATE	SIZE	A4	TITLE:
A0	2012/04/26	NEW	William Chen	x.XXX ±0.15	TANG	2025/04/10	SHEET	3/3	PH2.00 DUAL ROW SMT H=2.0
REV	DATE	MODIFICATION DESCRIPTION	CHANGE	Angle ± 3'	APPROVE	DATE	PROJ.	$\odot$	Customer NO.
				DIM TOL	Steven Zhao	2025/04/10			

**WCON**  
 Http: www.wcon.com

WCON-Dongguan  
 Tel: +86 769 85358920  
 Fax: +86 769 85358915  
 E-mail: sales@wcon.com

WCON-Kunshan  
 Tel: +86 512 57468408  
 Fax: +86 512 57468468  
 E-mail: sales@wcon.com