

No.1

将产品放入PE袋中, XXXPCS/袋



No.2

用封口机将PE袋封口

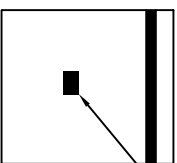

No.3

贴标签于PE袋中间位置



数量标签

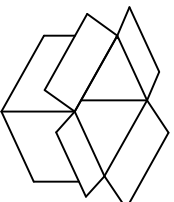
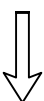

No.4

PE袋装入内箱, 内附两包干燥剂
内箱规格: CTN-23A (22*22*20cm)

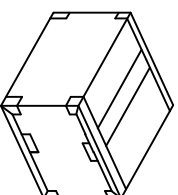

No.5

封箱

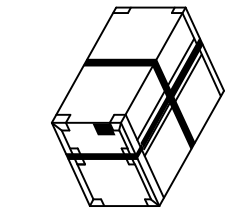

No.8

打包装带

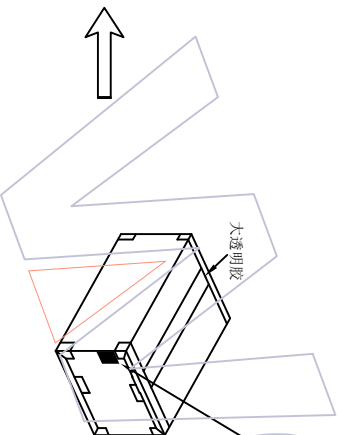

No.7

封箱及贴外箱标签

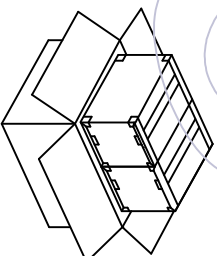

No.6

内箱放入外箱 (2内箱/外箱)
外箱规格: CTN-06 (47*23.5*22CM)

说明

1. 注意各标签样式、位置及方向的一致性;
2. 标签如客户有特殊要求, 则按客户要求黏贴;
3. 打外箱包装带时需注意, 打为十字型, 另出国内客户, 未打包装带。
4. 未尽事宜依据交货注意事项。

变更记录		变更说明		变更		核准		颜色		SCALE		WCON WCON ELECTRONICS (GUANGDONG) CO.,LTD 料号 PART NO: WD3811-2WS03XXBAXX (W) 品名 TITLE: 3.8mm Wire To Board, Male, Double Row, XHP, 袋装规范	
版本 REV	日期 DATE	变更描述 MODIFICATION DESCRIPTION	变更日期 CHANGE DATE	核准人 APPROVE	核准日期 APPROVE DATE	颜色 COLOR	材质 MATERIAL	UNIT	mm	设计 DESING	审核 CHECK		
A0	2023/03/16	NEW				X.XX	±0.10	mm	1:1	苏 珊	2023/03/16	A4	1/1
						X.XXX	±0.05						
						X.XXX	±0.02						
						Angle							
						X	± 2'						
						DIM	TOL						