

HSF

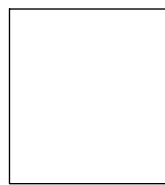

No.1

将产品放入PE袋中
PE袋规格: PE-06(18*25cm, T=0.1mm)

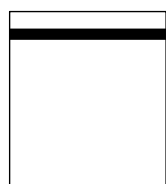
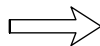

No.2

用封口机将PE袋封口

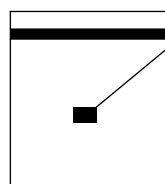
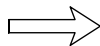

No.3

贴标签于PE袋中间位置

数量标签

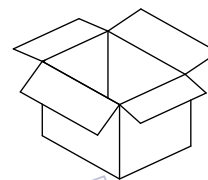

No.4

PE袋装入内箱, 内附两包干燥剂
内箱规格: CTN-23A (22*22*20cm)

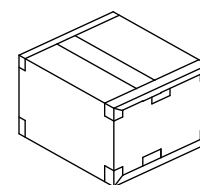
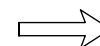

No.5
封箱

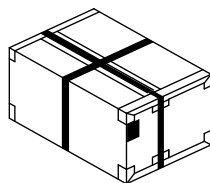

No.8

打包装带

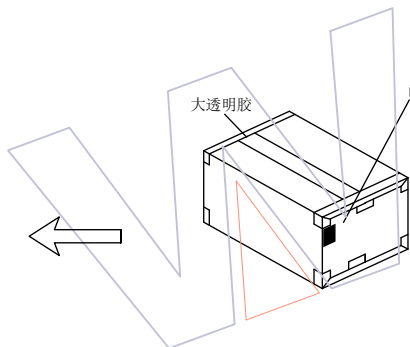

No.7

封箱及贴客户专用标签及ROHS标签

贴外箱标签

大透明胶

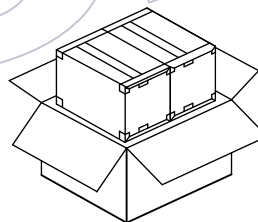

No.6

内箱放入外箱(2内箱/外箱)
外箱规格: CTN-06 (47*23.5*22CM)

3121B-2HXXB01&2			
PIN	PCS/袋	PCS/内箱	PCS/外箱
4	1000	12000	24000
6	1000	11000	22000
8	1000	10000	20000
10	800	8000	16000
12	800	7200	14400
14	800	6400	12800
16	800	5600	11200
18	500	5000	10000
20	500	4500	9000
22	500	4000	8000
24	500	3500	7000
26	500	3000	6000
28	500	2500	5000
30	300	2400	4800
32	300	2100	4200
34	300	1800	3600
36	300	1500	3000
38	300	1200	2400
40	200	1000	2000
42	200	800	1600
44	200	600	1200
46	100	500	1000
48	100	400	800
50	100	300	600

说明

1. 注意各标签样式、位置及方向的一致性;
2. 标签如客户有特殊要求, 则按客户要求黏贴;
3. 如订单量小于一内箱数量时, 外箱使用CTN-21,
4. 打外箱包装带时需注意, 打为十字型, 另出国内客户, 未打包装带。
5. 未尽事宜依据交货注意事项。

变更记事

						零件图	颜色		SCALE	1:1
						X.	COLOR		UNIT	mm
						X.X	±0.10	材质	SIZE	A4
						X.XX	±0.05	DESING	SHEET	1/1
						X.XXX	±0.02	设计	PROJ.	☉
A0	2023/04/15	NEW				Angle	审核	苏珊	2023/04/15	
版次	日期	变更说明	变更	核准		X.	± 2'			
REV	DATE	MODIFICATION DESCRIPTION	CHANGE	APPROVE		DIM	TOL	核准		
								核 准		
								APPROVE		

WCON

WCON ELECTRONICS (GUANGDONG) CO. LTD

料号 PART NO.

3121B-2HXXB01&2

品名 TITLE:

2.0mm Housing 'M' TYPE
中间带“倒扣”主体 袋装规范