

# HSF

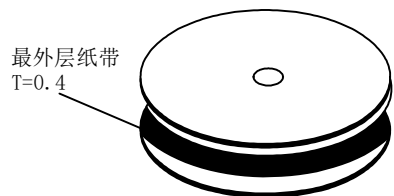

最外层纸带  
T=0.4

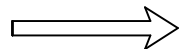

No. 2: 贴标签于纸盘

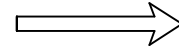

No. 3: 每箱内所有盘数  
堆叠使用PE膜缠绕固定

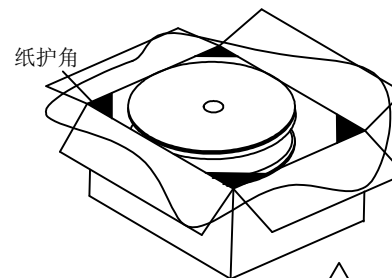
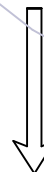

A2

No. 4: 纸箱需套防水袋PE-44, 再将端子装入纸箱, 并放入两包干燥剂, 封口, 再再纸箱四角放置纸护角, 纸箱规格: CTN-24A (41\*41\*21cm) 配CTN-J036 CTN-16 (56.5\*56.5\*22.5cm) 配CTN-J035 A1

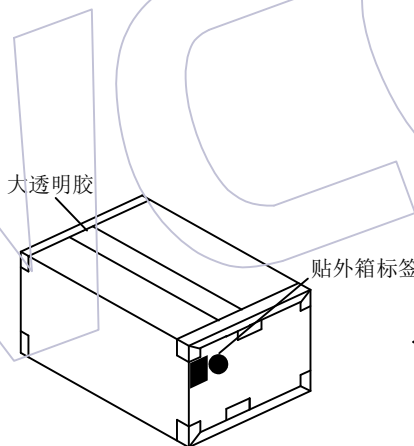
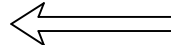

No. 5: 封箱及贴外箱标签

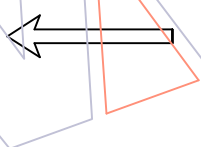

No. 6: 打包装带

No. 1: 端子卷入纸盘内, 最外层使用T=0.4纸带保护。  
纸盘规格: CTN-ZP03 (560\*560mm) 配CTN-16  
CTN-ZP01 (400\*400mm) 配CTN-24A A1  
备注: 1. 纸带与纸盘间隙在1mm以内,  
减少端子在纸盘中的晃动;  
2. 纸带与端子缠绕需紧密, 防止松脱;

### 说明:

1. 注意各标签样式、位置及方向的一致性;
2. 纸箱内空隙需用填充物填充

变更 记录	A2	2022/04/29	增加防水袋	苏珊		零件图	颜色	SCALE	fit	 WCON ELECTRONICS (GUANGDONG) CO., LTD 料号 PART NO. WF3961-TXXX01 品名 TITLE: Female Terminal, 18~22#AWG			
	A1	2022/03/29	增加400*400规格的防护	苏珊		X.X ±0.20	材质	UNIT	mm				
	A0	2022/03/14	NEW	苏珊		X.XX ±0.10	设计	DESING	苏珊		2022/04/29	SIZE	A4
	版次	日期	变更说明	变更	核准	X.XXX ±0.05	审核	CHECK	SHEET		1/1		
	REV	DATE	MODIFICATION DESCRIPTION	CHANGE	APPROVE	Angle	核准	CHECK	PROJ.		PROJ.	PROJ.	PROJ.
						X. ±2'	核准	APPROVE					
						DIM	TOL	APPROVE					