

HSF

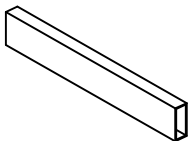

No: 1
产品装入真空管内
SG-B45 (600*6.0*35.0mm)

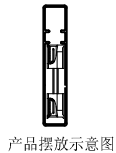
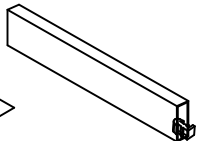

No: 2
塞塑胶塞

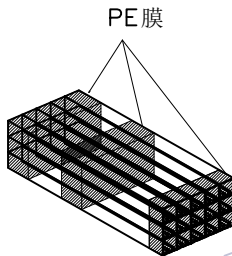

No: 3
20管为一扎(五层四排)
用PE膜固定每扎真空管两端及中间,
包住两端利角,以防划破胶袋

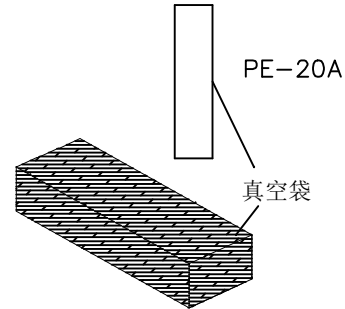

No: 4
3扎/内箱, 将包扎好的真空管装入真空袋,
外加2包干燥剂, 机台抽真空
PE-20A规格: 35*95cm

WCON 维康电子(广东)有限公司		3
WCON料号	环保	HSF
零件编号		
品名		
最小包装数量	PCS	日期
包装数量	PCS	制单号

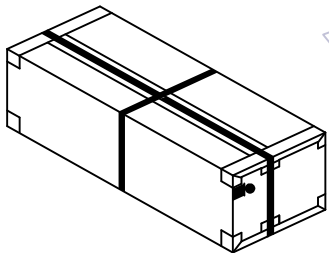

No: 8
打包装带

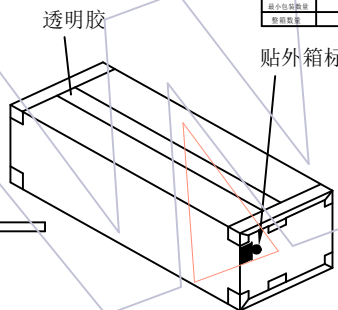

No: 7
封箱及贴标签于外箱侧面的左上角

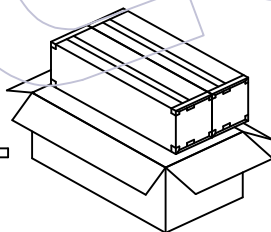

No: 6
内箱放入外箱(2内箱/外箱)
外箱规格: CTN-10C (双坑 65*33*19CM)

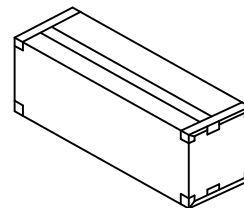

No: 5
将抽真空的产品, 放入内箱, 封箱
内箱规格: CTN-10A (63*15*17CM)

Pin	PCS/Tube	PCS/内箱	PCS/外箱
12	56	3360	6720
26	30	1800	3600
50	16	960	1920
68	12	720	1440
80	10	600	1200

说明:

- 产品如图所示型态放入真空管
- 注意各标签样式、位置及方向的一致性;
- 打外箱包装带时需注意, 打为十字型.
- 当不足数量外箱或内箱时, 内箱充当外箱使用, 并贴标签

变更 记录						零件图	颜色	SCALE	FIT	 WCON ELECTRONICS (GUANGDONG) CO. LTD 料号 PART NO. 3912-XXXSXXAB182T01 品名 TITLE: 1.27mm SDC XXP Male to Male转换座 H=20.0 L=18.2针长15.5 管装规范
						X.X	材质	UNIT	mm	
						X.XX	DESING	SIZE	A4	
						X.XXX	CHECK	SHEET	1/1	
						Angle	核准	PROJ.		
	A0	2023/01/06	NEW			X.	±0.20			
	版次	日期	变更说明	变更	核准	DIM	±0.10			
	REV	DATE	MODIFICATION DESCRIPTION	CHANGE	APPROVE	TOL	±0.05			